



LET'S BUILD A BETTER FUTURE

 Pergola
MB-OPENSKY 140

CHOOSE THE HIGHEST QUALITY

The **MB-OpenSky 140** pergola is not only a functional canopy for large areas, but also a stylish addition, perfectly matching the trends of modern construction.

The MB-OpenSky 140 structure is made of extruded aluminium, which guarantees its durability for years. The supporting posts are extremely tough and their geometry provides exceptional rigidity.

The profiles of the posts and purlins are connected by means of C and L type joints. An innovative method of spacing the profiles with custom-designed cleats makes it possible both to ensure the stability of the entire system and to create an aesthetic connection with no visible gaps.

The canopy is formed by a module composed of movable slats and fitted with a mechanism for changing their angle on an axis from 0 to 135°.



The concealed profile fastenings at the joints, with cleats bridging the gaps

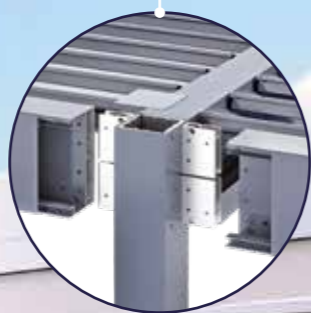

The motor concealed in the construction

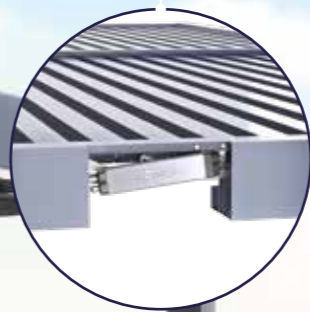
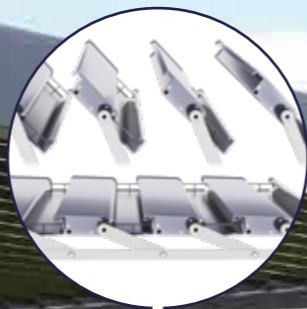

The roof module, with its pivotable slats

The slats fitted with seals for protection against rainwater



The drainage system concealed in the structure



Concealed footing



GO INTO DETAILS



PUT YOUR TRUST IN TRIED AND TESTED TECHNOLOGY

The ALUPROF **MB-OpenSky 140** pergola is resistant to snow load and powerful wind gusts.

Tests carried out on the system showed that, for structures with the dimensions of 6 m length × 4 m width × 3 m height, the permissible snow load is 200 kg/m², which corresponds to a covering of snow approximately 1000 mm deep and a simultaneous wind load of around 59 mph.

The slats feature tailor-made seals for protection against rainwater and there is a drainage system located in the posts. This ensures that water is efficiently fed through gutters and downpipes to the storm drain.

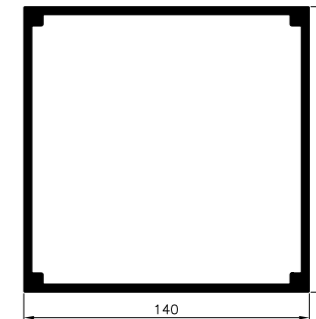

Square posts with sides measuring 140 mm

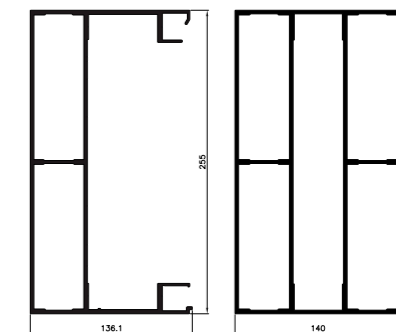

Outer and inner purlins measuring 140×255 mm

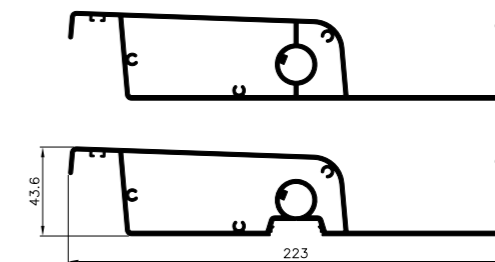

44×223 mm roof slats



Transverse,
free-standing,
two-bay pergola



Transverse,
wall-mounted,
two-bay pergola



Oblong,
free-standing,
two-bay pergola



Oblong,
wall-mounted,
two-bay pergola

CONFIGURE THE PERGOLA TO YOUR REQUIREMENTS

Our clients' requirements are many and various, so we offer the pergola in a range of sizes and configurations. Choosing the right dimensions for a pergola depends on the size of the area to be hidden from view.

The maximum dimensions of one section are 7 m length × 5 m width × 3 m height.

There is a free-standing version and a wall-mounted version, which comes complete with a custom-designed brackets, making it possible to insulate the wall. We also offer two-bay solutions, making it possible to extend the useable area. The system is therefore ideal not only as part of the patio or garden space of single-family homes but also for commercial buildings, where it can serve as a practical, modern, roofed element in the summer gardens of cafés and restaurants.





SMART MANAGEMENT AT YOUR FINGERTIPS

The **MB-OpenSky 140** pergola is equipped with a fully electric roof-control mechanism that is completely concealed in the structure. The angle of the slats can be smoothly adjusted to anywhere between 0 and 135°, which provides full control not only of how much sunlight is allowed in but also of the natural ventilation.

The mechanism can be operated using a remote control, a switch, a mobile phone app or the desired scenario programmed into a smart home control system.

The pergola can also be fitted with further accessories, including a wind sensor, a rain sensor and/or a sun sensor, all of which significantly enhance user comfort. If side blinds or panels are used, they can be fully integrated into the roof control system. This means that the entire pergola can be controlled via one device.

POWERED by **somfy**



STANDOUT STYLE

The ingenious design of the ALUPROF **MB-OpenSky 140** means that side blinds or sliding glass panels can be fitted. This opens up the possibility of creating a unique atmosphere, surrounded by nature, no matter how the weather is.

The pergola can also be equipped with LED lighting tailored to work without affecting the roof slats and heating unit. The solution provides for it to be installed in the form of a LED strip on the roof slats and a spotlight, together with additional lighting, around the upper edge.

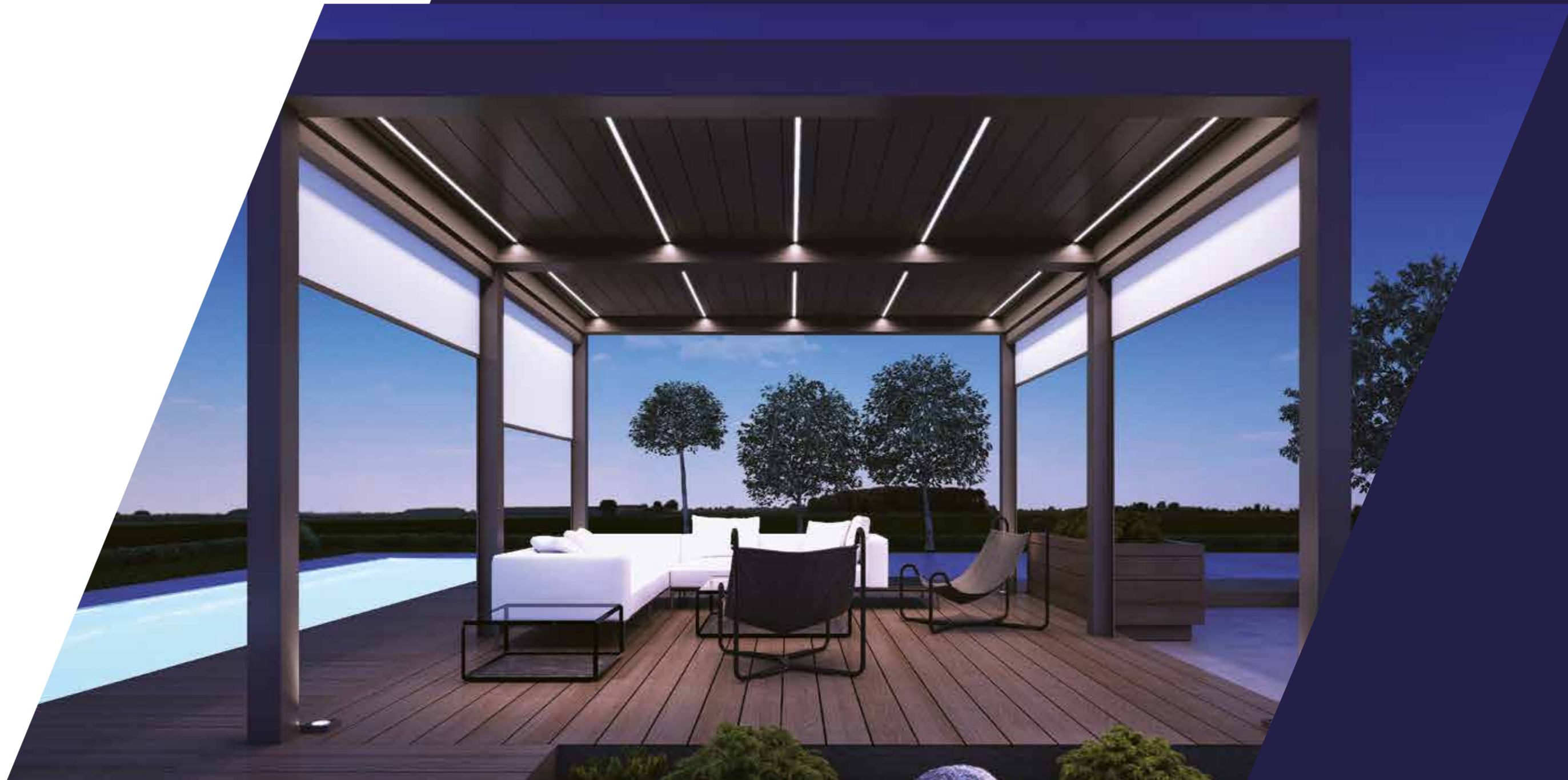



MAKE A PERFECT FIT

The extruded aluminium structure can be coated with any colour from the RAL palette. It can also be coordinated with the joinery of a building's window and/or façade.

The powder coating technology ensures that the coating is tough and will endure for years.

Standard colours of pergola **MB-OpenSky 140** construction

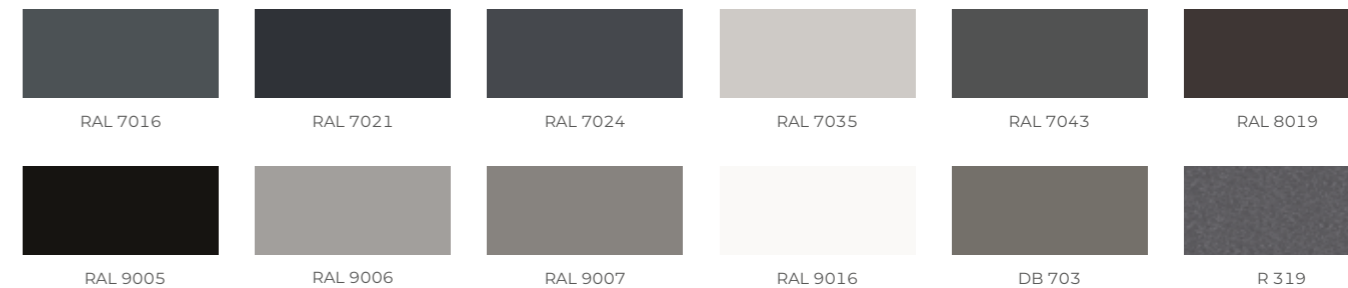

Basic colour range includes matt or structural coatings. The colours shown above are for illustrative purposes only, and the actual appearance may differ from the colour shown in photographs.



Download the folder
to your device

ALUPROF

ALUMINIUM SYSTEMS

ALUPROF SA Plant in Bielsko-Biała, ul. Warszawska 153, 43-300 Bielsko-Biała, Poland
tel. +48 33 81 95 300, fax +48 33 82 20 512, e-mail: aluprof@aluprof.eu

ALUPROF SA Plant in Opole, ul. Goślawicka 3, 45-446 Opole, Poland
tel. +48 77 400 00 00, fax +48 77 400 00 06, e-mail: opole@aluprof.eu